

## Model Name: santronLED Lowbay Light (A) 60 W

### Dimension

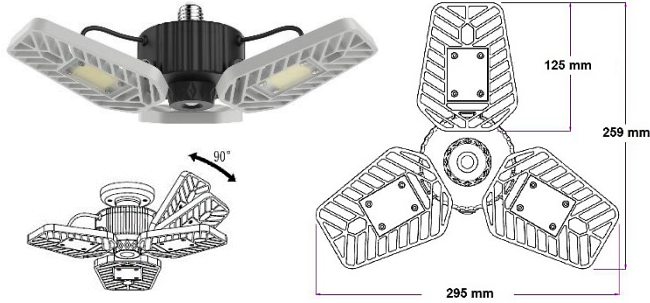

### Illumination Diagram

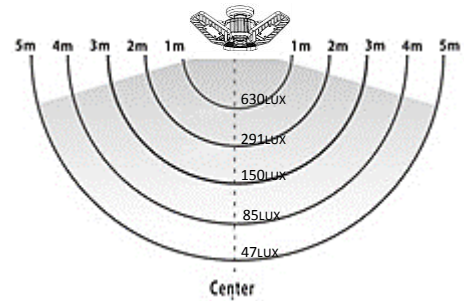

### Wiring



### Standard



### Specification

Model	ST-LOB-A-060-XX
Power Consumption	60w
Lamp Initial Flux	6000-6600lm
Input Voltage	AC90-260V / 50-60Hz
Power Factor	>0.90
Beam Angle	Horizontal: 60° - 320°
Working Temperature	-40°C~50°C
Working Lifetime	>35000 hours
IP Rating	IP44
Material	Aluminum Housing & PC Lens
Number of LED	3pcs of 20w
Number of Driver	3pcs of 20w
Support Type	E27
Product Dimension	295 x 259 x 95mm
Total Weight	0.8kg
Warranty	2 Years

Driver	
Driver Brand	Santron / Mean Well / Inventronics / MOSO
Driver Power	60W
Driver Input Voltage	AC90-260V / 50-60Hz
Driver Output Voltage	DC 72V
Driver Output Current	900mA ±5%
Power Factor	>0.95
Lightning Protection	N/A
LED Module	
LED Module Brand	Genesis / Epiled / Epistar / Bridgelux
LED Module Power	20W
LED Module Efficacy	100-110lm/w
LED Input Voltage	DC 72V
LED Input Current	280mA
Temperature Color	3000K (WW) / 5000K (CW) / 6300K (DL)
Color Rendering Index	>80

### Warning

- ◆ Do not disassemble the Lights by yourself, or it will cause the damage of the Light and its accessories
- ◆ Be carefully, do not touch the light without power off
- ◆ To make sure the lifespan and lighting effect, please do not pull wires and Keep the light from the crash and damage.

### Notice

- ◆ For safety secure, please only install, repair and examine by professionals person. Otherwise it may cause dangerous.
- ◆ The lamps must be operated with the matchable power supply
- ◆ Please don't install the lights under the high temperature and damp environment, or it will cause damage.
- ◆ Make sure no any covers like insulation blanket or similar materials in the surface of the Light