

Model Name: Kalinnda Solar Street Light Set 50W - M

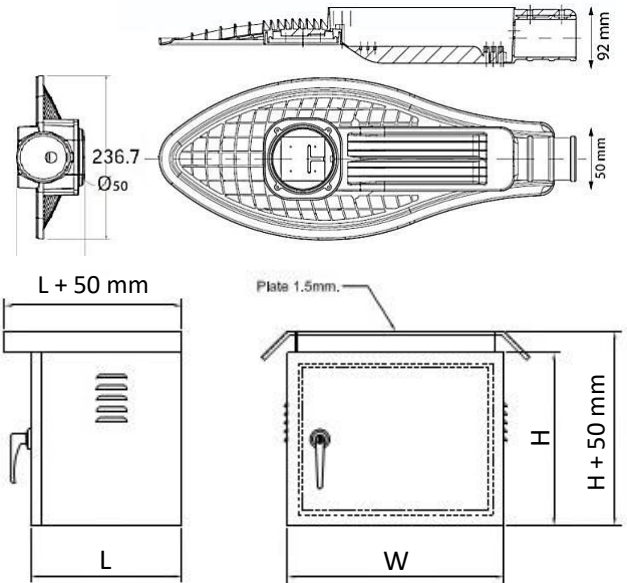

Dimension



Illumination Diagram

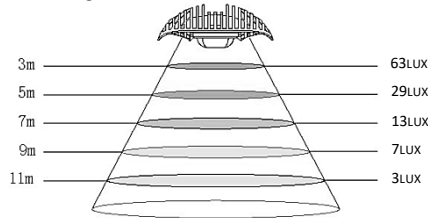

Specification

Model	KD-SSS-M-050-XX
Power Consumption	50W
Lamp Efficacy	100-110lm/W
Lamp Initial Flux	5000-5500lm
Input Voltage	DC12/24V
Temperature Color	3000K (WW) / 5000K (CW) / 6500K (DL)
Beam Angle	Horizontal: 90°
Material	Aluminum Housing & Glass Lens
Number of LED	1pcs of 50W
Number of Driver	1pcs of Adjustable Driver
IP Rating	IP65
Working Lifetime	35000 Hrs
Support Hole Size	Diameter 48mm (1.5in)
Size of Component Box	W450 x L250 x H450 mm
Size of Solar Panel	P1250 x N675 mm
Warranty	2 Years

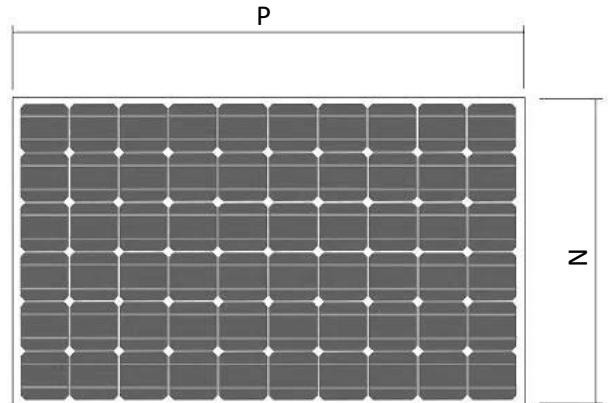

Other Component	
Power of Solar Panel	DC18V / 120W
Solar Control Charger	DC 12/24V / 20A / PWM
Battery	DC12V / 100AH / Deep Cycle
Battery Lifetime	Estimate 3 Years
Battery Re-Check Time	Every 6 Months
Charging Time	At least 5 Hrs (Start 09.00 AM)
Working Time	Estimate 12 Hrs (06.00 PM – 06.00 AM)

Warning

- ◆ Do not disassemble the Lights by yourself, or it will cause the damage of the Light and its accessories
- ◆ Be carefully, do not touch the light without power off
- ◆ To make sure the lifespan and lighting effect, please do not pull wires and Keep the light from the crash and damage.

Notice

- ◆ For safety secure, please only install, repair and examine by professionals person. Otherwise it may cause dangerous.
- ◆ The lamps must be operated with the matchable power supply
- ◆ Please don't install the lights under the high temperature and damp environment, or it will cause damage .
- ◆ Make sure no any covers like insulation blanket or similar materials in the surface of the Light