

Model Name: santronLED Street Light (C) 30W

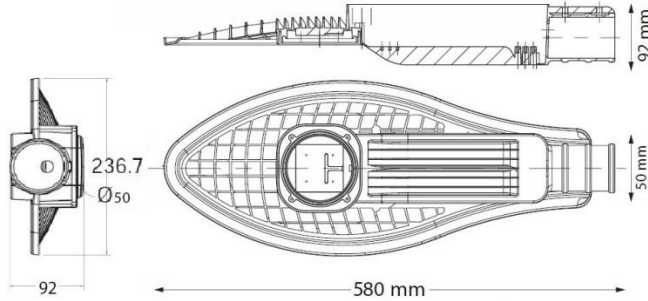

Dimension



Illumination Diagram

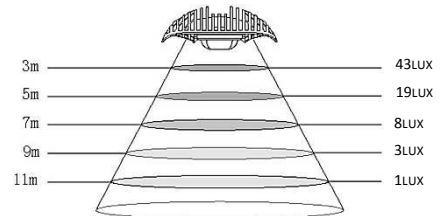

Wiring



Standard



Specification

Model	ST-STR-C-030-XX
Power Consumption	30w
Lamp Initial Flux	3000-3300lm
Input Voltage	AC90-260V / 50-60Hz
Power Factor	>0.95
Beam Angle	Horizontal: 90°
Working Temperature	-40°C~50°C
Working Lifetime	>35000 hours
IP Rating	IP65
Material	Aluminum Housing & Glass Lens
Number of LED	1pcs of 30w
Number of Driver	1pcs of 30w
Support Hole Size	Diameter 48mm (1.5in)
Product Dimension	580 x 237 x 92mm
Total Weight	2.8kg
Warranty	2 Years

Driver	
Driver Brand	Santron / Mean Well / Inventronics / MOSO
Driver Power	30W
Driver Input Voltage	AC90-260V / 50-60Hz
Driver Output Voltage	DC20-36V
Driver Output Current	900mA ±5%
Power Factor	>0.95
Lightning Protection	4000V
LED Module	
LED Module Brand	Genesis / Epiled / Epistar / Bridgelux
LED Module Power	30W
LED Module Efficacy	100-110lm/w
LED Input Voltage	DC30-33V
LED Input Current	1050mA
Temperature Color	3000K (WW) / 5000K (CW) / 6300K (DL)
Color Rendering Index	>85

Warning

- ◆ Do not disassemble the Lights by yourself, or it will cause the damage of the Light and its accessories
- ◆ Be carefully, do not touch the light without power off
- ◆ To make sure the lifespan and lighting effect, please do not pull wires and keep the light from the crash and damage.

Notice

- ◆ For safety secure, please only install, repair and examine by professional person. Otherwise it may cause dangerous.
- ◆ The lamps must be operated with the matchable power supply
- ◆ Please don't install the lights under the high temperature and damp environment, or it will cause damage.
- ◆ Make sure no any covers like insulation blanket or similar materials in the surface of the Light